

**Part A Multiple-Choice Questions****Questions 1 to 10**Answer all questions in the *Answer Booklet*.**Question 1**

Akashi wants to plant a flower garden in his back yard. He wants to choose a soil mixture which has a good buffering capacity.

He prepares and tests four different soil mixtures and measures the pH before and after a 4 week period. The table below shows the results of his experiment.

pH of Soil		
Soil mixture	pH of soil before	pH of soil after 4 weeks
A	7.0	4.3
B	7.0	6.7
C	7.0	7.7
D	7.0	9.1

Which soil mixture should Akashi use in his garden in order to have the best buffering capacity?

- A) Soil mixture A
- B) Soil mixture B
- C) Soil mixture C
- D) Soil mixture D



Question 2

Cells are able to produce the proteins they need to function properly.

Listed below are four steps involved in protein synthesis.

Steps	Protein Synthesis Process
1	Translation of mRNA into a protein
2	Genetic information of DNA copied to mRNA
3	End of protein synthesis
4	Attachment of mRNA to ribosome

Which of the above steps take(s) place in the cytoplasm of the cell?

- A) 2 only
- B) 1 and 2 only
- C) 1, 3 and 4 only
- D) 2, 3 and 4 only

Question 3

A toxicologist must assess the danger related to the human consumption of some rice which may be contaminated with arsenic, As.

Listed below are four possible factors which may affect the toxicity of this rice to humans.

1. Frequency of consumption
2. Volume of container
3. Concentration of arsenic, As, in rice
4. Mass of consumer

Which factors listed above should be assessed?

- A) 1 and 3
- B) 1,2 and 3
- C) 1,3 and 4
- D) 2,3 and 4



Question 4

The graph below represents the melting point of elements 1 to 54.

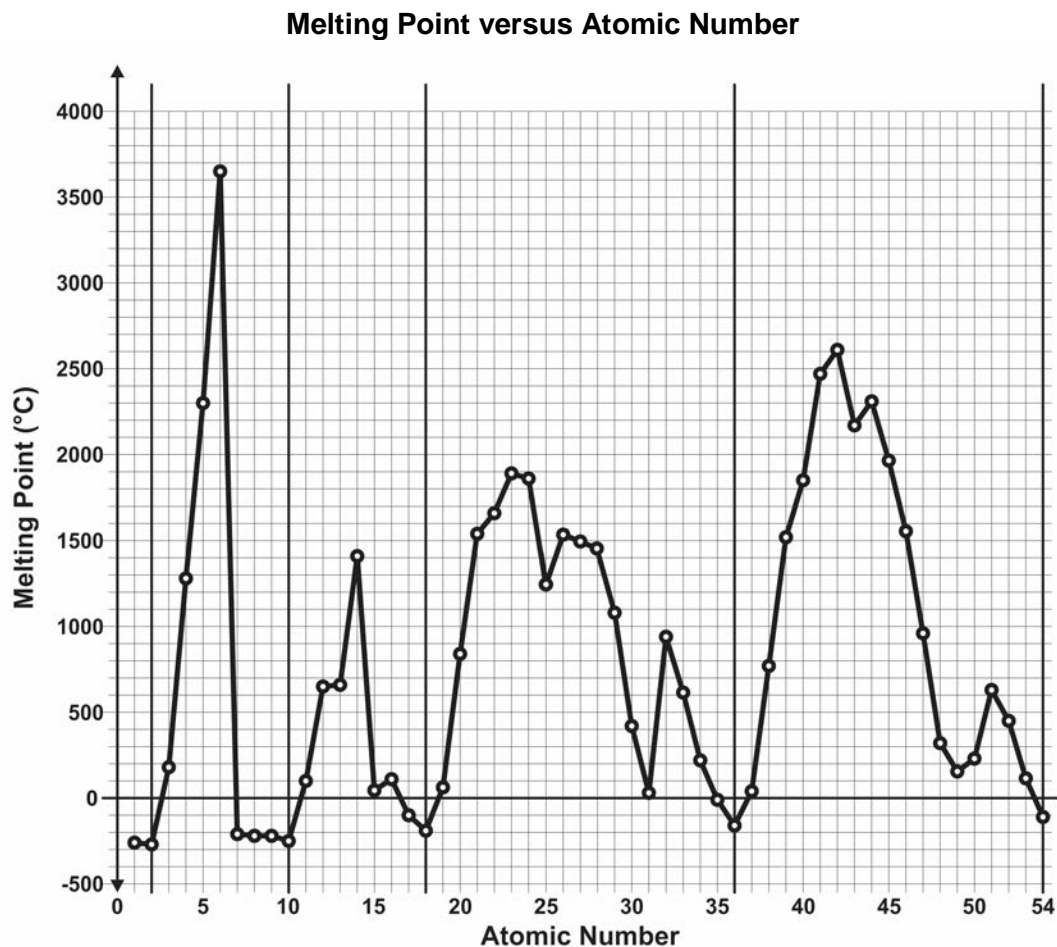

Which statement best describes the periodicity of melting point for the first 54 elements of the periodic table?

- A) The melting point decreases within a period.
- B) The melting point increases within a period.
- C) The melting point decreases, then increases within a period.
- D) The melting point increases, then decreases within a period.



Question 5

Farmers use fertilizers to promote the growth of fruits and vegetables. They can use both synthetic and natural fertilizers to achieve this result.

Fertilizer 1: K_2SO_4 is a popular synthetic product used on fields.

Fertilizer 2: P_2O_5 is a common natural product used in agriculture.

Which of the following correctly names the two fertilizers?

	Fertilizer 1	Fertilizer 2
A)	potassium sulphate	diphosphorus pentoxide
B)	dipotassium sulphate	phosphorus oxide
C)	potassium sulphide	diphosphorus pentoxide
D)	potassium sulphide	phosphorus pentoxide

Question 6

Ammonium hydroxide, NH_4OH , is a common compound found in many glass cleaners.

You made a sample solution of NH_4OH in the laboratory. You used 6.50 g of NH_4OH .

How many molecules of NH_4OH are in your sample solution?

- A) 3.78×10^{-22} molecules
- B) 1.85×10^{-1} molecules
- C) 1.12×10^{23} molecules
- D) 1.38×10^{26} molecules



Question 7

An engineering student is designing a circuit with a solenoid. The design is such that the circuit uses an acidic solution as shown below.

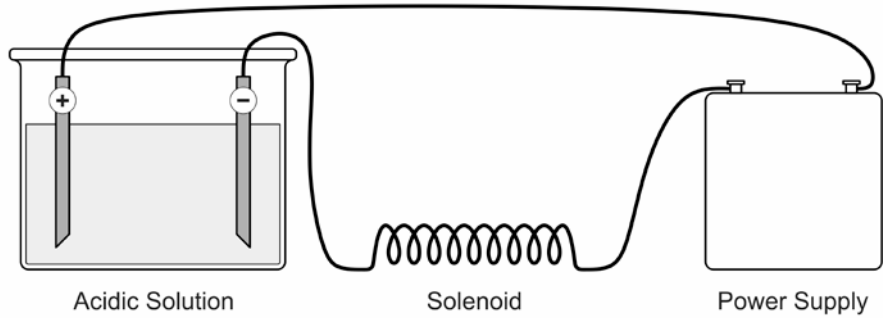

She wants to vary the intensity of the magnetic field of the solenoid by using three different acidic solutions which are illustrated below.

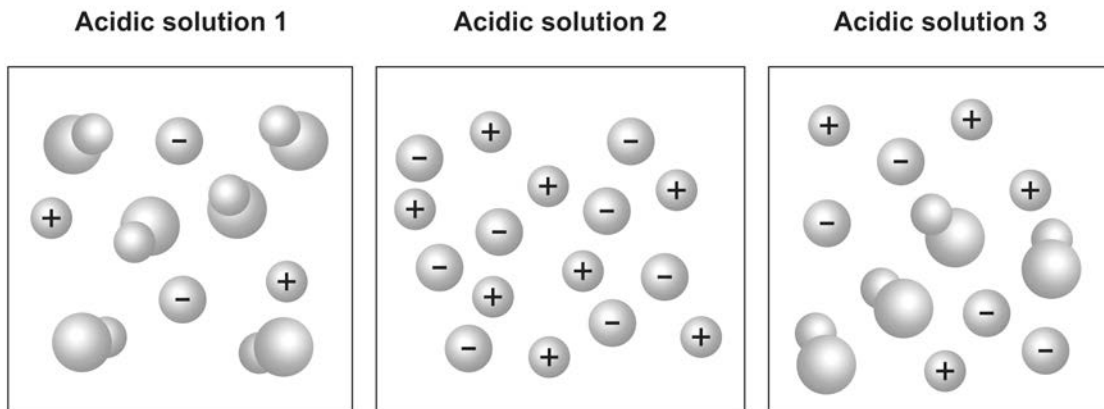

Which of the following correctly ranks the intensity of the magnetic field produced, from **strongest** to **weakest**, when each acidic solution is used in the circuit?

- A) 1, 3 and 2
- B) 2, 1 and 3
- C) 3, 2 and 1
- D) 2, 3 and 1



Question 8

A compass is placed within a magnetic field as seen in the diagram below.

Which of the diagrams below shows the compass needle pointing in the correct direction?

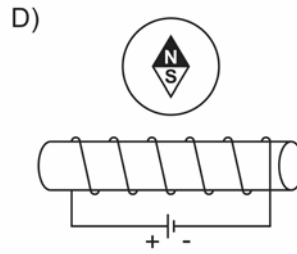
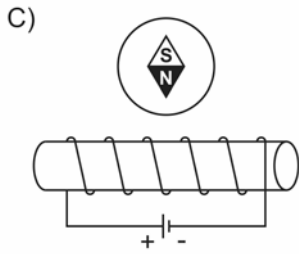
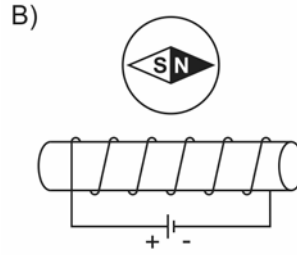
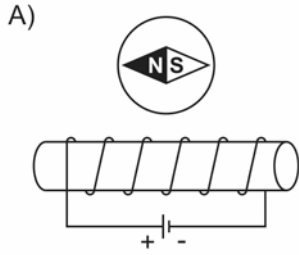



Question 9

Nathan is sitting on his sled, sliding down a snowy hill. The hill is angled at 20° from the ground. Nathan and the sled weigh 350 N.

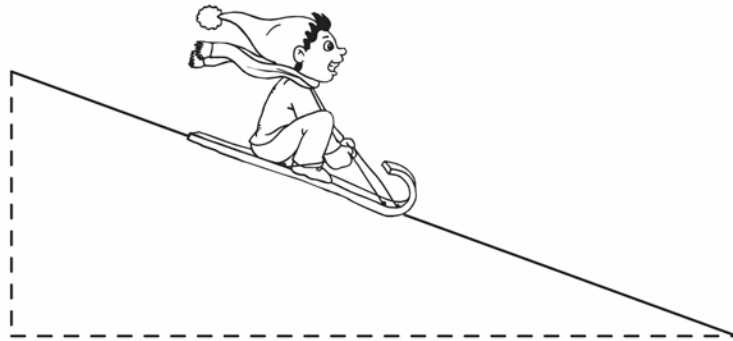

Which of the arrows below best represents the direction of the effective force acting on Nathan and the sled?

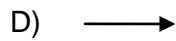
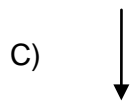
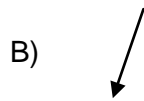
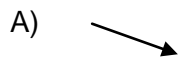



Question 10

Catya is designing a circuit for a go-cart track.

She must use a switch that will turn on either the green or red light.

She has constructed the circuit shown below.

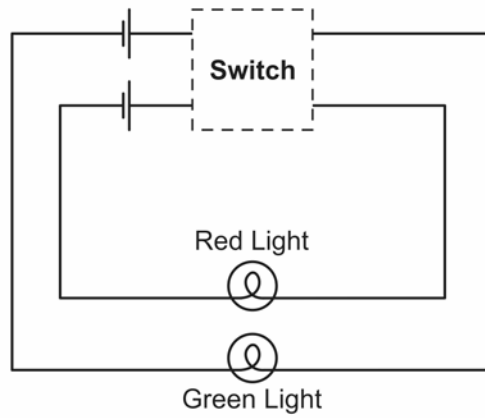

Which of the switches must Catya use?

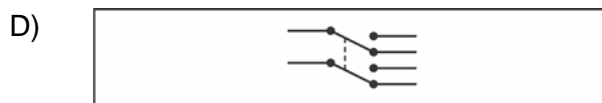
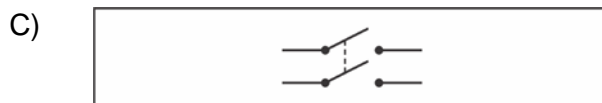
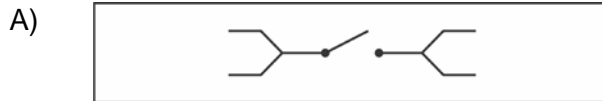

**Part B *Constructed-Response Questions*****Questions 11 to 20**Answer all questions in the *Answer Booklet*.**Question 11**Sodium and oxygen atoms react to form a chemical bond producing sodium oxide, Na₂O.

- a) Draw a schematic diagram to show the formation Na₂O.
- b) What type of bond is formed in Na₂O? How do you know?

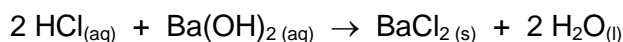
Question 12Barium chloride, BaCl₂, is used in fireworks to produce a bright green color. Gary tried to produce BaCl₂ by reacting hydrochloric acid, HCl, with barium hydroxide, Ba(OH)₂, according to the chemical reaction below.Gary used 100.0 mL of a HCl solution and obtained 7.8 g of BaCl₂.

What was the molar concentration of the HCl solution used in this reaction?

Note: *Significant figures will be evaluated in this question.*



Question 13

A nuclear plant in Chalk River, Ontario is responsible for producing 40% of the world's supply of medical isotopes.

At the facility, uranium-235 is used to produce molybdenum, Mo, as well as other products. One of the isotopes of molybdenum produced at Chalk River is Mo-99.

Possible isotopes of the element are:



- List the number of protons and neutrons found in each isotope of molybdenum.
- What type of nuclear transformation does the production of Mo-99 represent? Explain your answer.

Question 14

Stephanie has constructed the circuit below.

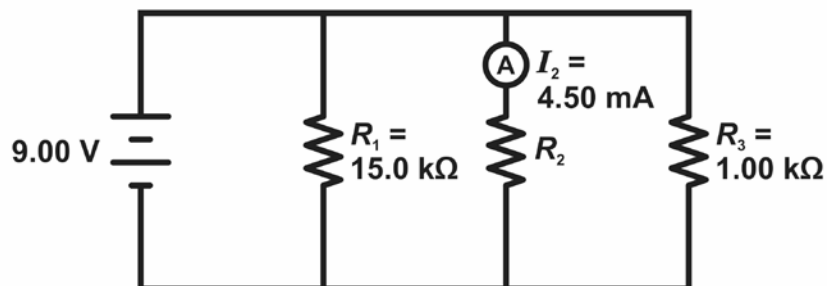

What is the equivalent resistance of the circuit above?

Note: Significant figures will be evaluated in this question.

Question 15

Coulomb's law states that there is force of attraction and repulsion between two electrically charged particles at rest.

Two positively charged particles at rest exert a force of $4.6 \times 10^3 \text{ N}$ on one another. The charge of the first particle is $6.0 \times 10^{-5} \text{ C}$ and the charge of the second particle is $2.0 \times 10^{-4} \text{ C}$.

What is the distance between the two charged particles?



Question 16

At the playground, Joseph is swinging on a wooden swing. When the height of the swing rose to 56 cm above the initial position, Joseph's velocity was 4.0 m/s. His mass is 45 kg.

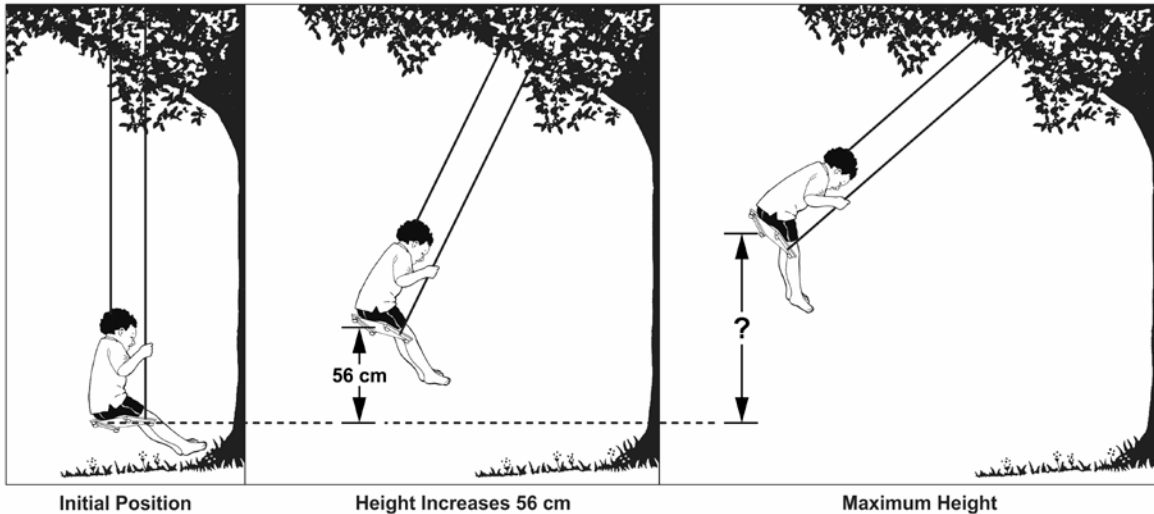

What is the maximum height above the initial position that Joseph will reach?
Assume there is no friction.

Note: Significant figures will be evaluated in this question.

Question 17

Jasmine and Andrew are examining an ear of corn which was produced through the fertilization of a female flower by pollen from another plant.

- Each kernel of corn is considered to be an individual offspring, F1, of the cross.
- They notice that about half the offspring kernels are golden and half are blue.
- Blue kernel colour is a recessive trait.



What is the genotype and phenotype of each parent?
Draw a Punnett square to support your answer.



Question 18

Germain and Lucy live with their three children.

Their daily tasks are divided so that each family member contributes to the smooth running of the household.

Below is a list of their household chores.

- They live in a 5 bedroom house.
- They have a big back yard with a swimming pool.
- Germain is in charge of doing groceries. He takes the only family vehicle, a van, to the corner market, where he buys local produce. He also goes to the nearby farm to buy organic beef and chicken.
- Lucy is in charge of keeping the kitchen clean. She uses the dishwasher at least once a day to save time washing the dishes herself. Since cooking is time consuming and both parents work, the family goes out to a restaurant or orders out two or three times a week.
- Sophie, the youngest daughter, takes care of the garden where they grow some of their own vegetables.
- Samuel likes to keep the bathroom clean. He often cleans up after his quick morning shower.
- Annie, the eldest daughter, is in charge of taking out the recycling, compost and garbage.

Based on what you know about the family,

- a) Identify one aspect of their lifestyle that helps to reduce their ecological footprint.
Explain how this aspect reduces their ecological footprint.
- b) Identify one aspect of their lifestyle that could be changed to further reduce their ecological footprint.
Explain how changing this aspect would further reduce their ecological footprint.



Question 19

Fertilizers are widely used in agriculture.

Farm #1 only uses potassium chloride, KCl , to fertilize the land. Farm #2 applies only potassium dihydrogen phosphate, KH_2PO_4 , as a fertilizer. Both farms are located on opposite sides of a very large lake.

Since farming can have an effect on the lake ecosystem, measurements have been taken over the past several years to record the changes in the depth of the lakeshore.

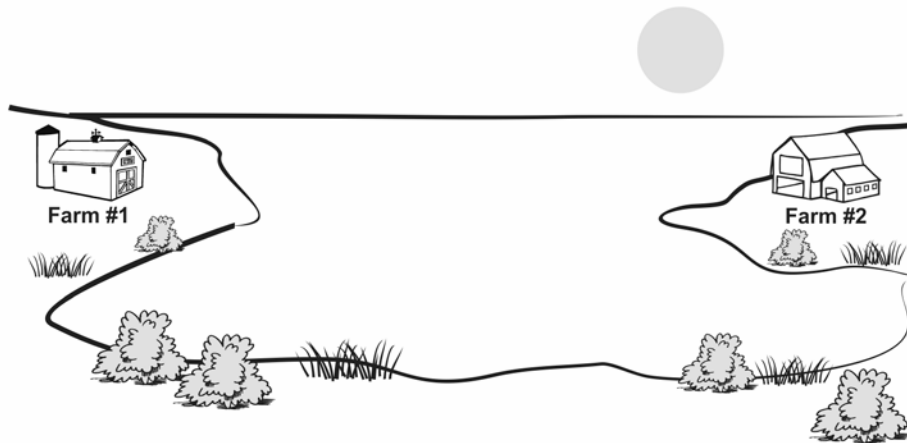

** Diagram not to scale **

- Which farm will NOT contribute to the effect of eutrophication?
Explain your answer.
- Which side of the lake will become shallower more quickly after several years of fertilizer usage?
Explain your answer.



Question 20

Sandy is pulling a toy cart on a varnished hardwood floor.

The wheels of the cart are made out of wood and are meant to rotate on an axle when the toy is pulled.

When Sandy pulls the toy, the wheels slide on the floor instead of rotating.

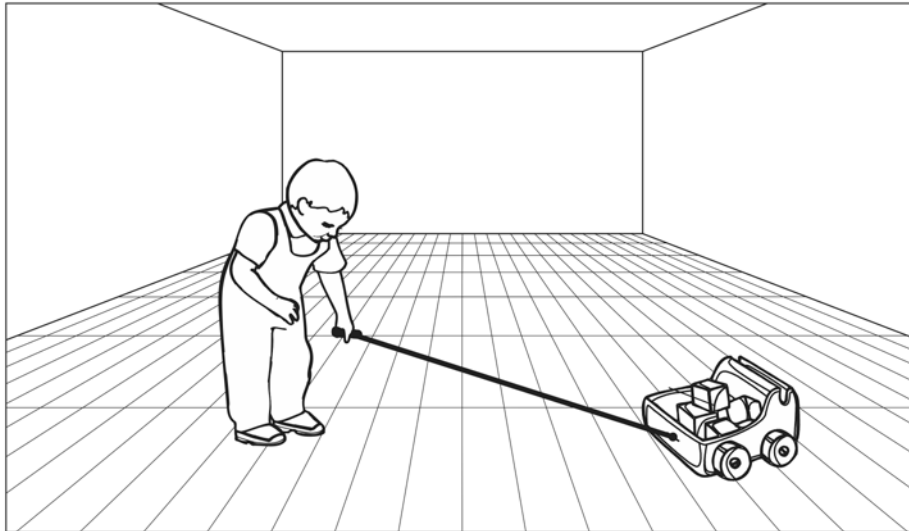

Using the concepts of friction and adhesion, identify two actions you could do to help the wheels on Sandy's toy cart roll instead of slide.
Explain your answer.



FORMULAS			
$C = \frac{m}{v}$	C: concentration m: mass v: volume	$W = \Delta E$	W: work ΔE : variation in energy
$V = RI$	V: potential difference R: resistance I: electric current intensity	$W = F\Delta d$	W: work F: force Δd : distance travelled
$R_{eq} = R_1 + R_2 + \dots$	R_{eq} : equivalent resistance	$F_g = mg$	F_g : gravitational force m: mass g: gravitational field intensity
$\frac{1}{R_{eq}} = \frac{1}{R_1} + \frac{1}{R_2} + \dots$	R_{eq} : equivalent resistance	$E_p = mgh$	E_p : gravitational potential energy m: mass g: gravitational field intensity h: height
$E = P\Delta t$	E: energy consumed P: power Δt : change in time	$E_k = \frac{1}{2}mv^2$	E_k : kinetic energy m: mass v: velocity
$P = VI$	P: power V: potential difference I: electric current intensity	$Q = mc\Delta T$	Q: quantity of heat m: mass c: specific heat capacity ΔT : change in temperature
$F_e = \frac{kq_1q_2}{r^2}$	F_e : electrical force k: Coulomb's constant q: charge of particle r: distance between two particles		



Appendix 2

QUANTITIES		
NAME	SYMBOL	VALUE
Coulomb's constant	k	$9 \times 10^9 \frac{\text{Nm}^2}{\text{C}^2}$
Gravitational field intensity on earth	g	9.8 N/kg
Specific heat capacity for water	c	4.19 J/g°C



PERIODIC TABLE OF THE ELEMENTS

		Key																	
		Element symbol		Atomic number		Atomic mass													
		H		1		1.01													
	I A 1																	VIII A 18	
1	1 H hydrogen 1.01																	2 He helium 4.00	
	II A 2																		
2	3 Li lithium 6.94	4 Be beryllium 9.01																	
			VIII B																
3	11 Na sodium 22.99	12 Mg magnesium 24.31	III B 3	IV B 4	V B 5	VI B 6	VII B 7	8	9	10	I B 11	II B 12	13 Al aluminum 26.98	14 Si silicon 28.09	V A 15 P phosphorus 30.97	VI A 16 S sulphur 32.07	VII A 17 Cl chlorine 35.45	18 Ar argon 39.95	
4	19 K potassium 39.10	20 Ca calcium 40.08	21 Sc scandium 44.96	22 Ti titanium 47.90	23 V vanadium 50.94	24 Cr chromium 52.00	25 Mn manganese 54.94	26 Fe iron 55.85	27 Co cobalt 58.93	28 Ni nickel 58.71	29 Cu copper 63.55	30 Zn zinc 65.39	31 Ga gallium 69.72	32 Ge germanium 72.59	33 As arsenic 74.92	34 Se selenium 78.96	35 Br bromine 79.90	36 Kr krypton 83.80	
5	37 Rb rubidium 85.47	38 Sr strontium 87.62	39 Y yttrium 88.91	40 Zr zirconium 91.22	41 Nb niobium 92.91	42 Mo molybdenum 95.94	43 Tc technetium 98.91	44 Ru ruthenium 101.07	45 Rh rhodium 102.91	46 Pd palladium 106.40	47 Ag silver 107.87	48 Cd cadmium 112.41	49 In indium 114.82	50 Sn tin 118.71	51 Sb antimony 121.75	52 Te tellurium 127.60	53 I iodine 126.90	54 Xe xenon 131.30	
6	55 Cs caesium 132.91	56 Ba barium 137.33	57-71 lanthanoids	72 Hf hafnium 178.49	73 Ta tantalum 180.95	74 W tungsten 183.85	75 Re rhenium 186.21	76 Os osmium 190.20	77 Ir iridium 192.22	78 Pt platinum 195.09	79 Au gold 196.97	80 Hg mercury 200.59	81 Tl thallium 204.37	82 Pb lead 207.20	83 Bi bismuth 208.98	84 Po polonium (209)	85 At astatine (210)	86 Rn radon (222)	
7	87 Fr francium (223)	88 Ra radium (226)	89-103 actinoids	104 Rf rutherfordium (267)	105 Db dubnium (268)	106 Sg seaborgium (271)	107 Bh bohrium (272)	108 Hs hassium (270)	109 Mt meitnerium (276)	110 Ds darmstadtium (281)	111 Rg roentgenium (280)	112 Cn copernicium (285)	113 Uut ununtrium (284)	114 Fl flerovium (289)	115 Uup ununpentium (288)	116 Lv livermorium (293)	117 Uus ununseptium (292)	118 Uuo ununoctium (294)	
			6	57 La lanthanum 138.91	58 Ce cerium 140.12	59 Pr praseodymium 140.91	60 Nd neodymium 144.24	61 Pm promethium (145)	62 Sm samarium 150.36	63 Eu europium 151.96	64 Gd gadolinium 157.25	65 Tb terbium 158.93	66 Dy dysprosium 162.50	67 Ho holmium 164.93	68 Er erbium 167.26	69 Tm thulium 168.93	70 Yb ytterbium 173.05	71 Lu lutetium 174.97	
			7	89 Ac actinium (227)	90 Th thorium 232.04	91 Pa protactinium 231.04	92 U uranium 238.03	93 Np neptunium (237)	94 Pu plutonium (244)	95 Am americium (243)	96 Cm curium (247)	97 Bk berkelium (247)	98 Cf californium (251)	99 Es einsteinium (252)	100 Fm fermium (257)	101 Md mendelevium (258)	102 No nobelium (259)	103 Lr lawrencium (262)	